

# Glass door hardware

TESA

ASSA ABLOY



# New Glass door hardware, never seen before



TESA ASSA ABLOY offers solutions at technological forefront for all types of doors, even for glass doors.

Simple and independent systems, that provide flexibility to any building that requires to operate secure in an increasingly changing environment

The new range of glass door hardware from TESA ASSA ABLOY, is the result of the work to develop advanced solutions for any type of doors and material: a complete and balanced range who defines new standards for glass doors.

### Full range

No matter the material: TESA ASSA ABLOY has the product range needed to fit doors made of any material. And when it comes to glass, our range suits all types of pedestrian gates.

### Integral solution

No matter the size of the project: TESA ASSA ABLOY is the ideal partner for an integrated solutions that enable use one single brand to solve all access and security needs.

### Versatile

Discover a new universe of possibilities: master keying, a variety of handles or minimalist glass strikes.

### Security

Like other TESA ASSA ABLOY product ranges, the new glass hardware has been created keeping all security requirements.



### Convenient

Try our range, you will not have any problem when installing new glass doors or replacement, with the added benefit of reliability and security that characterize TESA ASSA ABLOY.

### Universal

With a single model for swing doors, left or right hand, outwards or inwards opening, avoiding duplication stocks.

### Resistant

Reliable locks do not neglect the smallest detail. The range of glass hardware has been created based on the latest trends in interior design, achieving a perfect balance between quality and aesthetics.

### Smooth Opening

Mechanisms with curved rotation axis for a soft opening smoothly.

# Glass door solutions

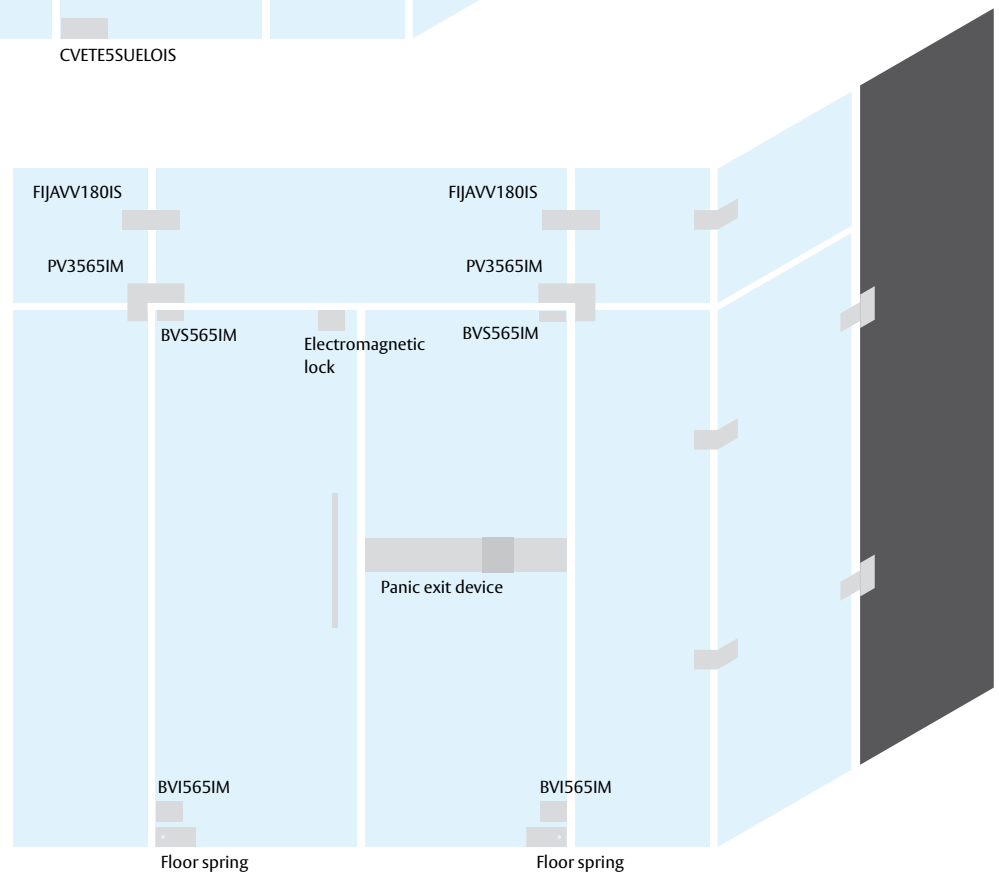
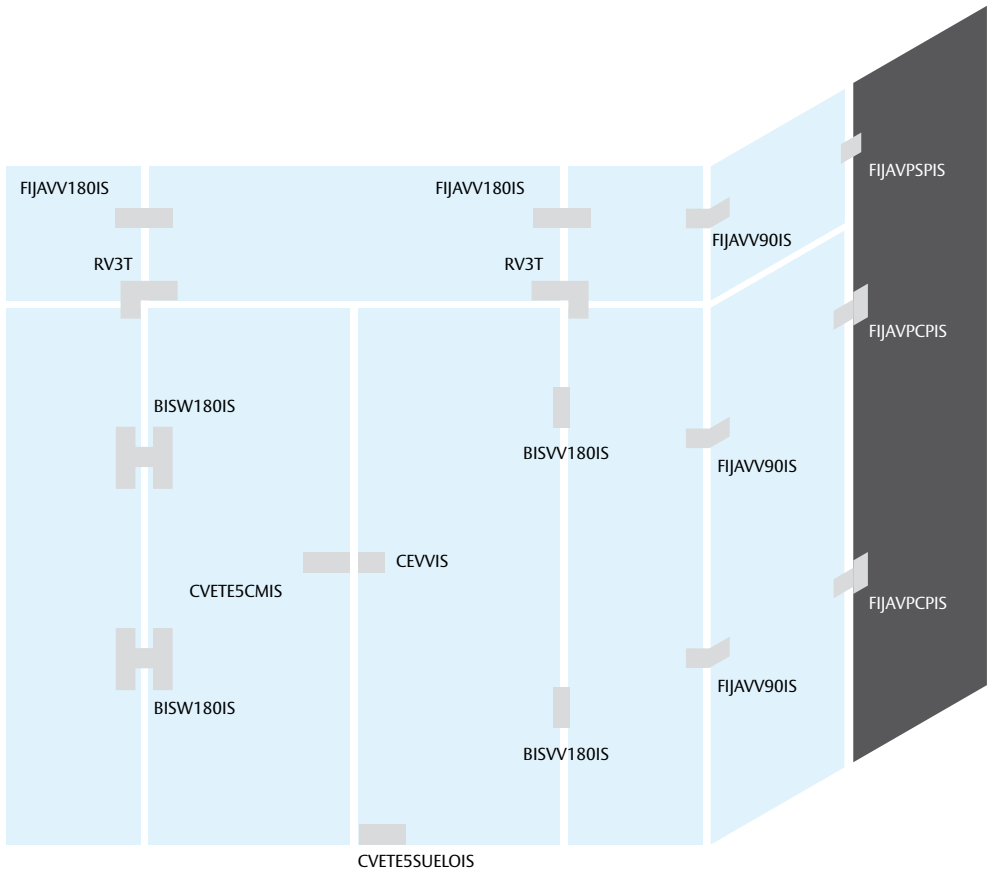

# Glass door solutions

## Contents

<b>Glass door solutions</b>	<b>4</b>
<b>Glass door locks</b>	<b>6</b>
Glass series	6
Handles	7
Pull handles	7
Strikes	8
Hinges	8
<b>Glass door accessories</b>	<b>9</b>
Fittings	9
<b>Patch fittings for Glass Doors</b>	<b>10</b>
<b>Hinges for glass doors</b>	<b>11</b>
<b>Top pivots for glass doors</b>	<b>12</b>
<b>Complementary ranges</b>	<b>14</b>
Door closers	14
Access control systems	14
Panic exit devices	14
Electromagnetic devices	15



# Glass door locks

## Glass series

- » Stainless steel finish, AISI 304.
- » Applicable with euro profile cylinders.
- » Applicable with TESA ASSA ABLOY's handle range.

### CVECECMIS

- » Lock with thumb turn cylinder and a pair of Cubo handles.
- » The thumb turn withdraws the latchbolt.
- » Reversible latchbolt.

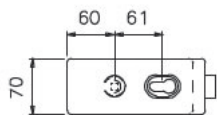

### CVETE5CMIS

- » Lock with TE5 cylinder and pair of Cubo handles.
- » The key withdraws the latchbolt.
- » Reversible latchbolt.

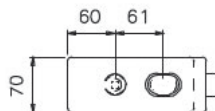

### CVISCCMIS

- » Lock with a pair of Cubo handles.

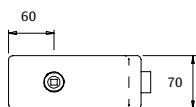

Model	Function	Handle	Cylinder	Glass thickness	Finish
CVECECMIS	Handle + thumb turn	CUBO	-	8 - 10 mm	Stainless steel
CVECECMSIS	Handle + thumb turn	SENA	-	8 - 10 mm	Stainless steel
CVETE5CMIS	Handle + cylinder	CUBO	TE5	8 - 10 mm	Stainless steel
CVETE5CMSIS	Handle + cylinder	SENA	TE5	8 - 10 mm	Stainless steel
CVISCCMIS	Handle	CUBO	-	8 - 10 mm	Stainless steel
CVISCCMSIS	Handle	SENA	-	8 - 10 mm	Stainless steel

# Glass door handles

## Handles

- » Optional handles for glass door Locks.
- » Stainless steel handles, AISI 316.

Sena



Vector



Xara



Zafira



Sector



## Pull handles

- » Stainless steel pull handles, AISI 316.

Mare



# Glass door accesories

## Strikes

### CEVVIS

- » Strike for glass mounting.
- » Stainless steel finish, AISI 304.
- » Reversible.

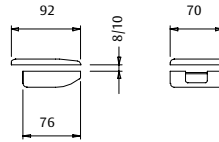

### CEVPIS

- » Strike for wall mounting.
- » Stainless steel finish, AISI 304.

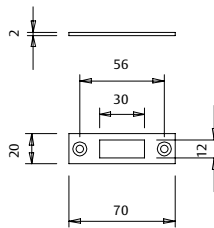

Model	Mounting	Glass thickness	Finish
CEVVIS	Glass	8 - 10 mm	Stainless steel
CEVPIS	Wall	-	Stainless steel

## Hinges

### BISVP180IS

- » Glass to wall hinge.
- » Stainless steel finish, AISI 304.

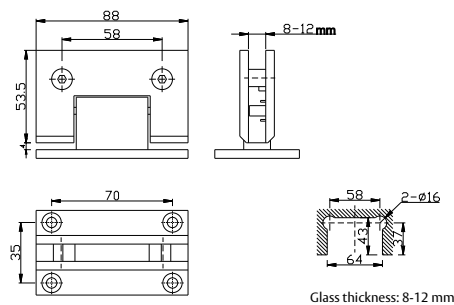

Model	Mounting	Turn	Glass thickness	Finish
BISVP180IS	Wall - glass	180°	8 - 10 mm	Stainless steel



# Glass door accessories

## Fittings

### FIJAVPCPIS

- » Glass to wall fixing brackets.
- » Stainless steel finish, AISI 304.

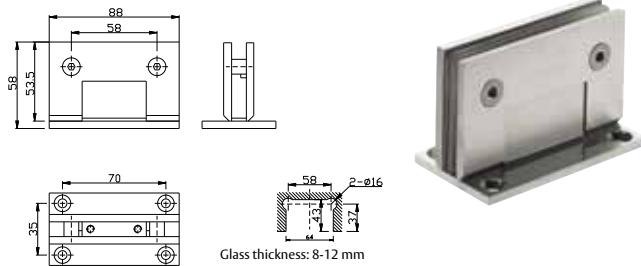

### FIJAVPSPIS

- » Glass to wall fixing brackets.
- » Stainless steel finish, AISI 304.

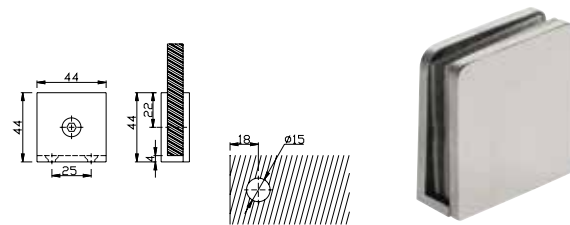

Model	Mounting	Angle	Glass thickness	Finish
FIJAVPCPIS	Wall - glass	-	8 - 10 mm	Stainless steel
FIJAVPSPIS	Wall - glass	-	8 - 10 mm	Stainless steel



# Patch fittings for Glass Doors

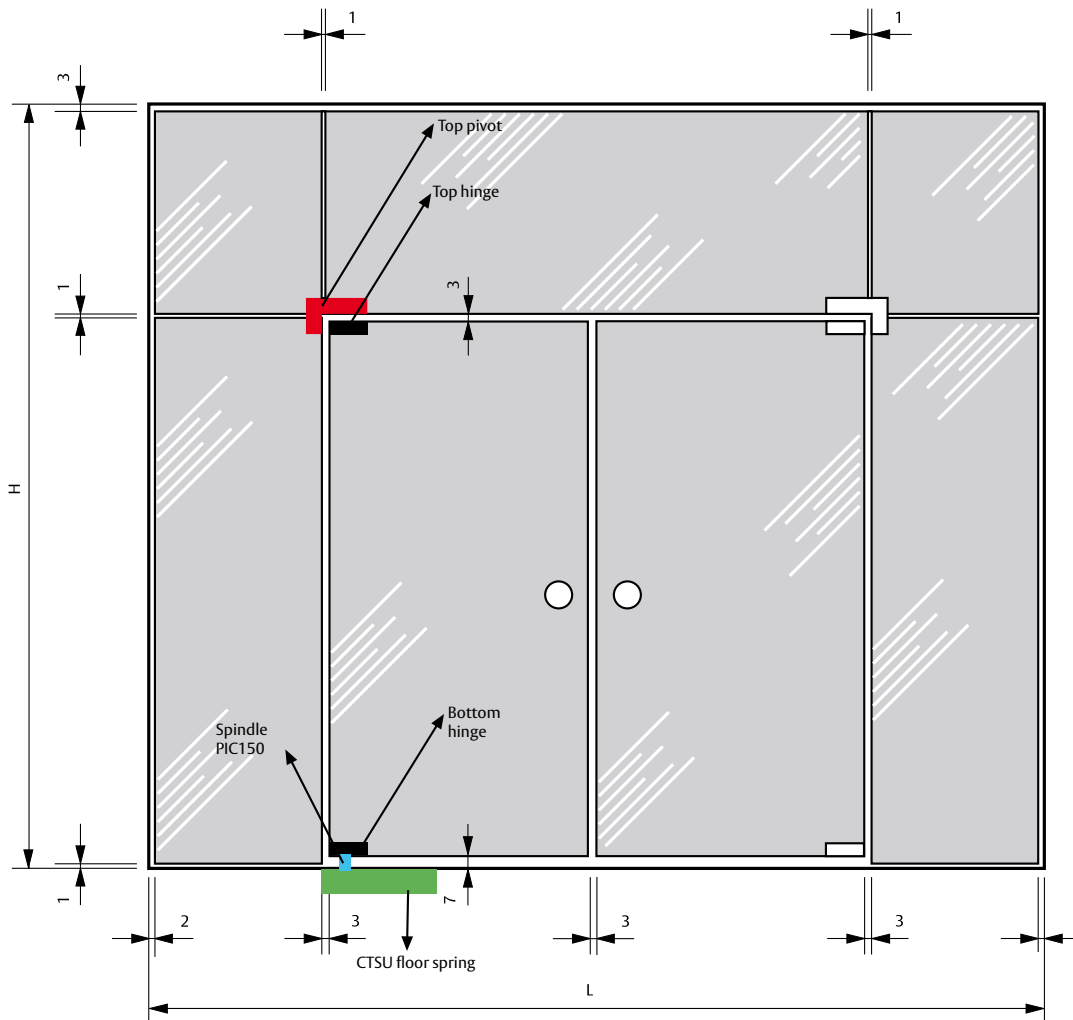

Elements required in order to complete installation of glass doors

- Bottom hinge with square spindle coupling for MA034 spindles.
- Top hinge with cilindric coupling for top pivots
- Top Pivot for frame installation. The configuration of the frame will determine which pivot type should be used.
- CTSU floor spring or PICE floor pivot

## Types of top and bottom hinges

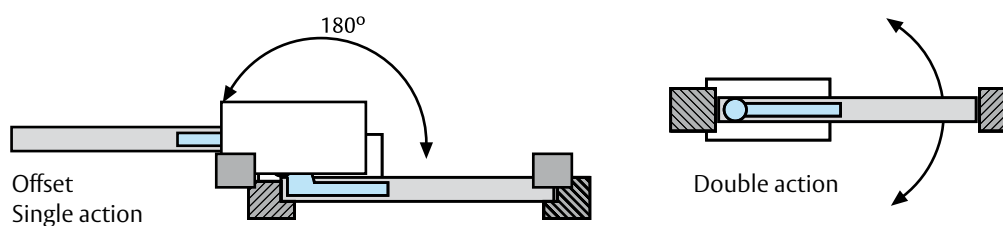

# Hinges for glass doors

## Hinges for glass doors - double action

### BVI565V

- » Bottom hinge with PIC150 spindle coupling.
- » Spindle position at 55 or 65 mm. Adjustment +/- 3 mm.
- » Glass thickness: from 8 to 12 mm.
- » Maximum weight: 80 kg.
- » Finishes: IB, IM.

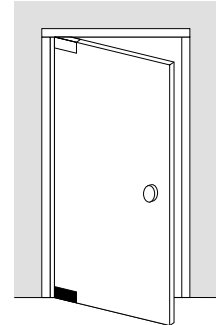
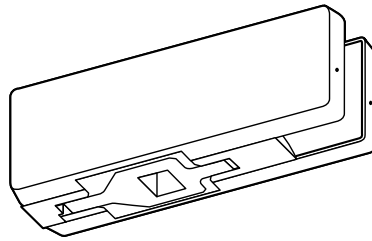

Dimensions

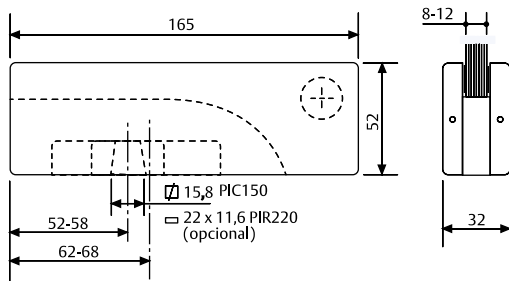

Glass machining

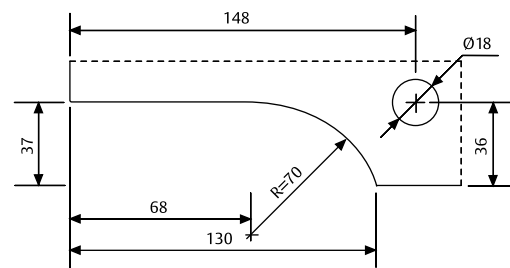

Model	Finish	Hand	Type	Door weight Kgs
BVI565 V	AN - AO	-	Bottom	80
BVI565 V	IM - IB	-	Bottom	80

### BVS565V

- » Top hinge for double action doors.
- » Pivot position at 55 or 65 mm, adjustment +/- 3 mm.
- » Finishes: IB, IM.

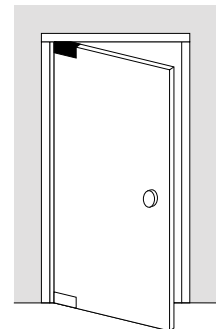
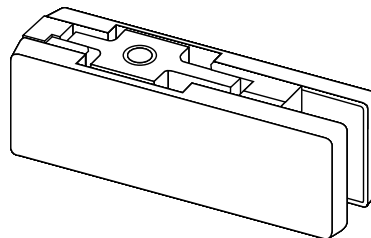

Dimensions

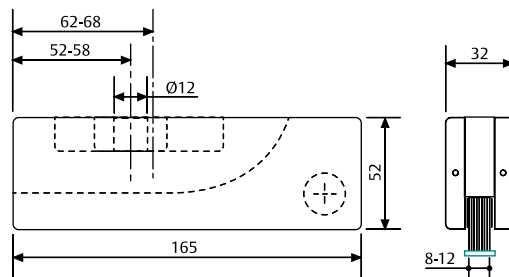

Glass machining

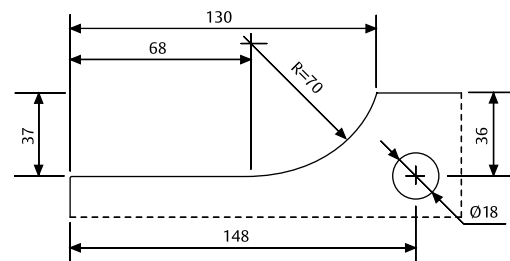

Model	Finish	Hand	Type	Door weight Kgs
BVS565 V	IM - IB	-	Top	80

F

# Top pivots for glass doors

## Double action

### PV1565V

- » Type 1 top pivot.
- » Designed for BVS565V and BVS100V top hinges.
- » Finish: CB.

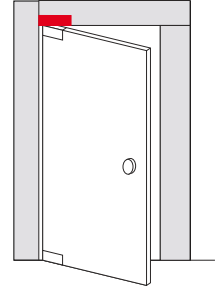
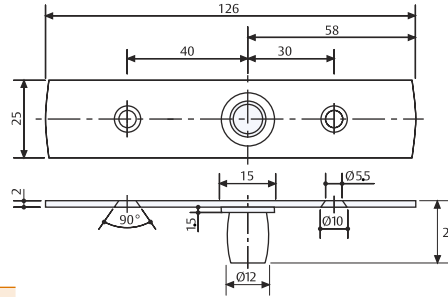

Model	Finish
PV1565V	IM - IB

### PV2565V

- » Type 2 top pivot with spindle position at 55mm.
- » Pivot position at 55/65 mm. Adjustment +/- 3 mm.
- » Designed for BVS565V top hinge.
- » Finishes: IB, IM.

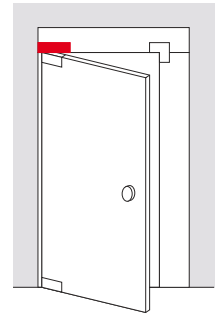
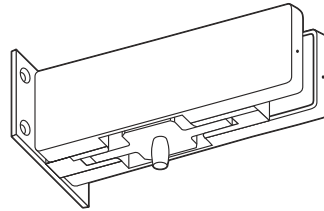

Dimensions

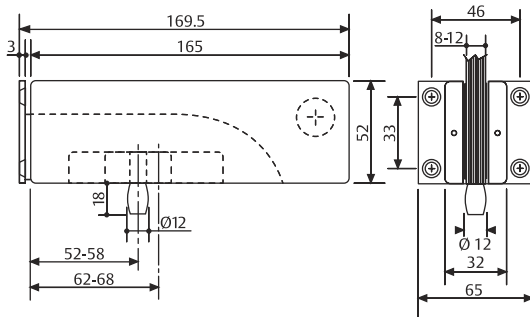

Glass machining

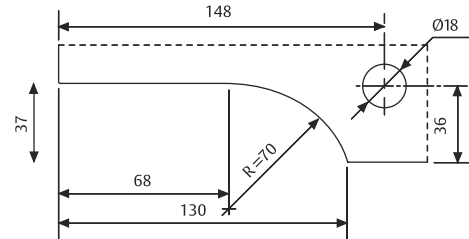

Model	Finish
PV2565V	IM - IB

# Top pivots for glass doors

## Double action

### PV3565V

- » Type 3 top pivot.
- » Pivot position at 55/65 mm. Adjustment +/- 3 mm.
- » Finishes: IB, IM.

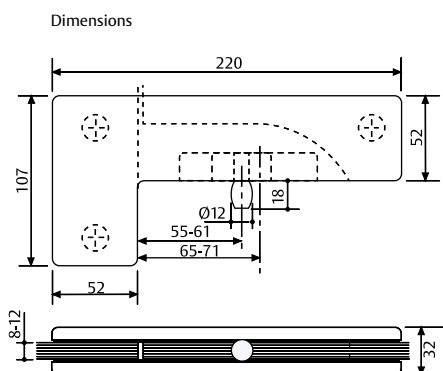
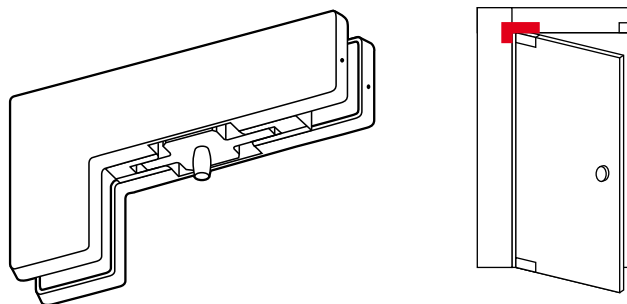

Glass machining

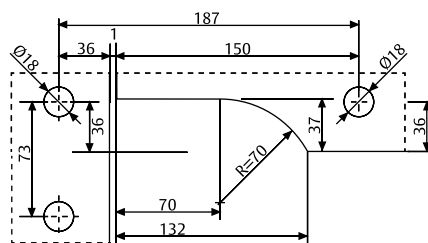

Model	Finish	Hand
PV3565V	IM - IB	-

### PV4100V

- » Type 4 top pivot.
- » Pivot distance from door from 100 mm. minimum.
- » Designed for BV100V top hinge.
- » Finishes: IB, IM.

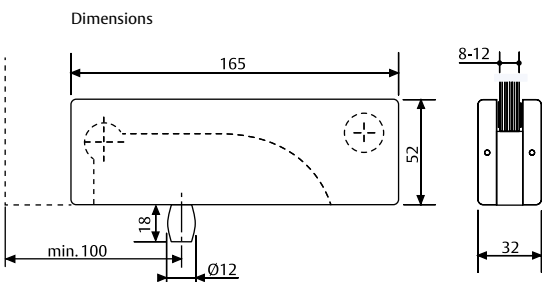
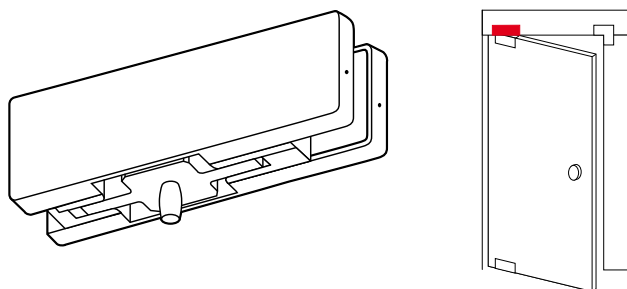

Glass machining

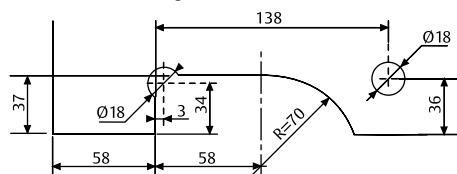

Model	Finish	Hand
PV4565V	IM - IB	-

F

# Complementary ranges

## Floor springs

- » CTSU100 series, the most versatile floor springs, valid for doors up to 100kg and 1.10 m wide.
- » Reversible and valid for single and double action doors.
- » For more information, please, check “floor springs” catalogue.



Model	Description
CTSU100SR	Doorcloser without axis
PIC150	Standard square axis

## Access control systems

- » Stainless steel adapter for glass door
- » Suitable for glass door, thickness between 10 and 16 mm
- » Applicable with electronic and mechanical locks, these must be ordered apart from the adaptor
- » For more information, please, check “Access control” catalogue

### References for single leaf adaptor:

Model	Description
STHVIDL1DI	Adaptor for 2UB4A lock, right hand
STHVIDL1II	Adaptor for 2UB4A lock, left hand

### Reference for double leaf strike adaptor.

Model	Description
STHVIDCODI	Strike adaptor, right hand.
STHVIDCOII	Strike adaptor, left hand.



## Panic exit devices

- » Stainless steel adapters for glass door
- » Suitable for glass door, thickness between 10 and 16 mm
- » Applicable with Universal or TOP panic series, these must be ordered apart from the adaptor
- » For more information, please, check “Panic Exit devices” catalogue

### Adaptor references for Universal series

Model	Description
19K1CRIAI	Adaptor for Universal 1910 model
19K5CRIAI	Adaptor for Universal 1930 or 1950 models

### Adaptor references for Top series

Model	Description
TOPK1CRIAI	Adaptor for TOP1S model
TOPK5CRIAI	Adaptor for TOP3S model



# Complementary ranges

## Electromagnetic devices

- » Electromagnetic rim locks for glass doors
- » Suitable for door with any glass thickness
- » For more information, please, check "Electromechanical devices" catalogue



Model	Description
SCGG054SS	CEM Rim lock, 545Kg
SCGGDB00S	Adaptor for strike
SCGAKG00S	Kit for the lock



---

## **ASSA ABLOY**

Talleres de Escoriaza, S.A.U.  
Barrio Ventas, 35 • E-20305 Irun • SPAIN  
Tel.: +34 943 669 100 • Fax: +34 943 633 221  
[www.tesa.es](http://www.tesa.es)

ASSA ABLOY is the global leader in door opening solutions,  
dedicated to satisfying end-user needs for security, safety and convenience.